

REHABILITATION STANDARDS MANUAL



Specifications and Numbers

Instructions to Bidders

Instructions to Bidders	1-4
-------------------------	-----

Concrete - General Specifications

1. Pier Foundations	5
2. Continuous Footing	5
3. Concrete Slab	5
4. Concrete Block Walls	6
5. Crawl Space Ventilation	6
6. Exterior Steps	6
7. Concrete Drives	6
8. In conflict with	6

Carpentry – General Specifications

8. Floor Framing	7
9. Floor Repair	7
10. Exterior Flooring	7
11. Wall Framing	8
12. New Stud Wall	8
13. Closets – Clothes	8
14. Closets – Linen	8
15. Closets – Heat Unit	8
16. Scuttle Hole	8
17. Roof Framing	8

Roofing – General Specifications

18. Built Up Roofing	10
19. Shingle Roofing	10
20. Mineral Surface Roofing	10
21. Rubberoid Granulated Roofing	10
22. Roof Ventilation	10
23. Lead Boots for Vent Pipes	10

Windows – General Specifications		
---	--	--

24.	Window	11
25.	Window Repair	11
26.	New Window Screens	11
27.	Window Screens – Rescreening	11

Doors – General Specifications		
---------------------------------------	--	--

28.	Door Repair	12
29.	New Interior Doors	12
30.	New Bi-Fold Doors	12
31.	New Exterior Doors	12
32.	Sliding Glass Doors	12
33.	Aluminum Screen Doors	12
34.	Wood Screen Doors	12

Exterior – General Specifications		
--	--	--

35.	Exterior Siding – Clapboard, Bevel or Drop	13
36.	Exterior Siding – T1-11	13
37.	Exterior Siding – Vinyl	13
38.	Exterior Finish – Stucco	13
39.	Soffit and Fascia – Aluminum and/or Vinyl	13
40.	Fascia – Repair	13
41.	Soffit – Replacement or Repair (Wood)	13
42.	Leaders and Gutters	13

Insulation – General Specifications		
--	--	--

43.	Insulation	14
-----	------------	----

Ceiling & Wall – General Specifications

44.	Ceiling Finish – Drywall	14
45.	Drop Ceiling – Drywall	14
46.	Ceiling Finish – Popcorn	14
47.	Ceiling Finish – Knock-Down	14
48.	Ceiling and Wall Finish – Veneer Plaster	14
49.	Ceiling and Wall Finish – Drywall	14
50.	Wall Finish – Drywall	14
51.	Wall Finish Knock-Down	14
52.	Wall and Ceiling Finish ¼” Drywall	15
53.	Wall Finish – Paneling	15

Painting – General Specifications

54.	Painting	15
-----	----------	----

Cabinets - General Specifications

55.	Cabinets – Medicine	15
56.	Cabinets – Vanity	15
57.	Cabinets – Base	15
58.	Cabinets – Wall	15
59.	Counter Tops	15

Bathroom – General Specifications

60.	Wall Finish - Ceramic Tile	16
61.	Ceramic Fixture Set	16
62.	Grab Bars	16

Flooring – General Specifications

63.	Flooring Underlayment	16
64.	Floor Covering – Tile	16
65.	Floor Covering – Sheet Vinyl	16
66.	Floor Covering – Carpet	16
67.	Base Trim	16

Appliances – General Specifications	
--	--

68.	Appliances	17
69.	Range Hoods	17

Systems – General Specifications	
---	--

70.	Mechanical Equipment Repair	17
71.	Heating	17
72.	Electrical	17
73.	Plumbing	18

Pest Extermination – General Specifications	
--	--

74.	Pest Extermination	20
-----	--------------------	----

Construction Debris – General Specifications	
---	--

75.	Construction Debris	20
-----	---------------------	----

A.D.A. Requirements	
----------------------------	--

	This section is to be used only as a guide for estimating jobs. The actual A.D.A. Code shall be used for all specifications.	21-29
--	--	-------

Lead-Based Paint Maintenance Planning Tool	
---	--

	This Lead-Based Paint Maintenance Planning Tool is a guide designed for you to develop a custom fit checklist to conduct lead-based paint maintenance activities in a safe manner.	30-39
--	--	-------

APPENDIX “P” - PAINTING	40-45
-------------------------	-------

WORK TYPE SYMBOLS

C= Painting **D**= Demolition **R**= Repair **N**= Replace with New **P**= Provide with New

INSTRUCTIONS TO BIDDERS

A. INSPECTION OF SITE

Each bidder should visit the job site and fully familiarize him/herself with the conditions and all labor and materials required. The bidder should fully familiarize him/herself with the facilities available and the difficulties and restrictions pertaining to the performance of the contract. The bidder should thoroughly examine and familiarize him/herself with the drawings, technical specifications and all other contract documents. The contractor, by execution of the contract, shall in no way be relieved of any obligations under it due to his/her failure to receive or examine any form or legal instrument, or failure to examine the site and consider all existing conditions. The City of Ocala will be justified in rejecting any protest based on facts pertaining to all conditions, which he/she should have examined prior to the initial bid submittal.

B. REQUEST FOR PAYMENT

Each request for payment invoice must be submitted in writing, on company letterhead. It should list the work completed line by line with associated cost and be signed by the contractor. Each invoice must be submitted with a completed request for payment form (available from the Community Development Office) two weeks prior. To process a check for any given Friday, the invoice and request for payment form must be received by the Community Development Office two weeks prior. City checks are generally issued every Friday. No requests for payment will be processed before final inspection by the building department has been performed and approved for that work.

C. CHANGE ORDERS AND WORK ITEMS EXCHANGE REQUEST FORM

Each **change order request must be in writing**, on company letterhead, and signed by the contractor. All change orders must be approved by the rehab specialist prior to field implementation. To request payment for a change order, it must be submitted prior to the completion of the job. A work item exchange request form must be filled out if any work items are going to be exchanged. The form requires the signature of the contractor and the Rehabilitation Specialist prior to initiating any work exchanges.

D. CITY OF OCALA BUILDING DEPARTMENT PERMITS AND INSPECTIONS

Each rehabilitation job shall have the required permits (IE: building permit, plumbing permit, electrical permit and H.A.R.V. permit). The contractor is responsible for purchasing the building permit and insuring that his/her sub-contractors purchase their required permits. All electrical, plumbing, mechanical, and structural inspections must be made by the City of Ocala Building Department. The contractor is required to notify the Building Department for each of the required inspections. When calling the Building Department (352) 629-8421, for an inspection, you will need the address, owners name, contractor (on plumbing and electrical inspections, the plumber or electrician is the contractor) and the permit number.

E. COMMUNITY DEVELOPMENT INSPECTION

When opening a roof for repair and/or replacement of roof framing, bracing or sheathing an inspection is required prior to drying in the roof. Additional structural inspections may be required during the rehabilitation project. **Any framing members exposed during the rehab project such as framing studs, ceiling joist, floor joist, rafters, sheathing and etc. are to be inspected / approved by the Rehabilitation Specialist prior to closing.** All exterior plywood and framing lumber must be labeled exterior grade and seen by the Rehabilitation Specialist.

F. REHABILITATION SPECIFICATIONS

These specifications are intended to be used with a “work write up sheet.” Specific items on these sheets intended to be used for bidding will be referred to on the work write up sheet.

The phrase “or equal” shall be interpreted to mean equal in quality and integral properties and similar in design and will be required to be approved by the rehab specialist prior to use.. All materials and workmanship shall comply with applicable codes and requirements of the Florida Building Code. All necessary permits as determined by the City Building Department are to be purchased and properly displayed on the job site. The general contractor is responsible for all general specifications – concrete, carpentry and roofing when applicable, as well as the specification number specified in the work write up.

G. MATERIAL AND PRODUCTS

OBJECTIVE

To provide materials of such kind and quality as to assure that the dwelling will provide:

- a. Appropriate structural strength
- b. Adequate resistance to weather and moisture
- c. Reasonable durability and economy of maintenance

QUALITY OF MATERIALS AND PRODUCTS

All materials and products used as replacement or additions in rehabilitation construction shall be of good quality conforming to general accepted good practice. The suitability of special materials and products, not conforming to national standards, shall be determined by the City of Ocala’s Community Development Rehabilitation Specialist after an evaluation of its properties and performance characteristics.

STANDARDS FOR MATERIALS AND PRODUCTS

For specific requirements of new materials and products used as a replacement or addition to a dwelling being rehabilitated, reference shall be made to the Florida Building Codes and the standards of the American Society for Testing Materials.

QUALITY SPECIFICATIONS

1. Scope of work shall include all labor, materials, equipment, permits, drawings (if any) and services necessary for the proper completion of the rehabilitation specified in the work write up.
2. The work write up shall take precedence over this standard specification; and when in conflict, the material, equipment and workmanship called for in the work write up shall be required.
3. The **drawings of the floor plan, if any, are diagrammatic only**, illustrating the general intention of the Rehabilitation Specialist; they do not show all of the work required, exact dimensions, or construction details.
4. Workmanship shall be done in accordance with the standards, which the trades know as a “workman-like manner.” No work will be accepted that does not conform with the standard of a “workman-like manner.” All work shall be done in accordance with the standards of all trades and this work is to be done in a “workman-like manner.”
5. Repairs shall be made to all surfaces damaged by the contractor resulting from his work under this contract at no additional cost to the owner or the City of Ocala.
6. Applicable laws and regulations of Federal, State and City of Ocala code of ordinances shall be complied with in case of conflict, the most stringent shall apply.
7. Quantities and locations will be indicated in the bid specifications sheets.
8. No substitutions for any items listed in the specifications will be accepted unless approved in writing by the Rehabilitation Specialist.
9. When rehabilitation work is in progress, the **general contractor will not be paid for any work deviating from the work write up specifications unless approved through the construction change order procedures, with written consent of the Rehab specialist.**

10. The general contractor shall be held responsible for the execution of this work in accordance with the true intent of the drawings, write up, or specifications. Contractor is to complete a first class job and furnish all labor and materials required whether or not each and every method is specifically mentioned.
11. All materials furnished shall be new and without any indication of damage or breakage. If usually packaged, the material shall be brought to the job in original unbroken containers.
12. Brand names mentioned together with phrase "or equal" indicates that other makes of equal quality and suitability may be used. The Rehabilitation Specialist reserves the sole right to decide equality of materials.
13. Materials and conditions not specified, shall be the best adapted for the purpose.
14. Installation of any materials or products shall be in accordance with the manufacturer's directions and specifications.
15. The general contractor shall be responsible for damage due to negligence to all existing floor covering, walls, ceiling, appliances, household goods, and items such as shrubs throughout construction.
16. During construction **all debris shall be contained in an on-site trash container or dumpster** which will be provided by the contractor.

Concrete – General Specifications

These general specifications are mandatory where applicable.

- A. No concrete is to be placed over grass, roots or foreign materials.
- B. All reinforcing bars shall be free of scale, rust or coating that will reduce concrete bond.
- C. All reinforcing bars shall be sized as designated by the Florida Building Code.
- D. All concrete slabs shall be separated from existing construction by a ¼" asphalt impregnated expansion joint material. Additional expansion joints shall be installed as otherwise designated by the FBC and in the work write up.
- E. Fill dirt shall be clean, compacted and free of deleterious material.
- F. All materials used for concrete forms shall be removed after concrete has set. Voids in exposed concrete surfaces shall be filled with compatible non-aggregated cement material and finished smooth.
- G. Installment of all foundations, slabs and footings will also conform with the standard for hurricane resistant residential construction code.

1. **Pier Foundations Minimums**

Piers shall be solid one-piece, reinforced concrete (2,500 P.S.I.) minimum dimension 8" x 8" x 16" C.M.U. according to the Florida Building Code. Height equal to the distance from the bottom of the joist or sill to the existing ground surface. All piers are to be 8' on center with galvanized metal termite shields, unless otherwise designated in the work write up.

Pads shall be 24" x 24" x 8" poured 12" below finished grade with 3 #5 pieces of re-bar each way. One #5 bar is to be tied to the bottom steel and extend within 3" of the top of pier. Pads shall be poured using 2,500 P.S.I. concrete. All connections from pier to joists must be set in the concrete. Connectors used must be appropriate for the application when leveling is necessary all jacking and leveling shall be done before installing new piers, spacers are not acceptable.

2. **Continuous Footing**

All continuous footings shall be 16" wide x 8" deep extending at least 12" below the finished grade, reinforced with two #5 re-bar, lapped 25" at each splice. Poured concrete shall be 2,500 P.S.I. Re-bar shall have a minimum concrete coverage of 3" from both the bottom and side of the footing. No concrete shall be poured over grass, roots, or debris.

3. **Concrete Slab**

All concrete slabs will be a minimum 4" thick using 6"x6" NO. 10/10 wire mesh poured with 2,500 P.S.I. concrete. No concrete shall be poured over grass, roots, or debris. Soil shall be pre-treated per requirements of the Florida Building Code.

4. Concrete Block Walls Minimums

Exterior block walls shall be constructed on a 10"x16" continuous footing. 8"x8"x16" masonry blocks shall be used with the correct mortar mix for the application. Top course shall be a lintel block with two #5 re-bar lapped 25" at all splices and poured solid using 2,500 P.S.I. concrete.

5. Crawl Space Ventilation

Provide cross ventilation for crawl space under wood floor systems. Opening area shall comply with the Florida Building Code, with wire mesh sized according to the same.

6. Exterior Steps

Minimum tread size shall be no less than 10" wide. Maximum riser height is 7^{3/4}" on all exterior steps. All stairs with three or more risers above grade or floor level shall be equipped with a handrail as required by the Florida Building Code.

- a. Pre-Cast – Steps shall be standard size placed over a min. 4" concrete slab.
- b. Hollow Poured – Steps shall be formed and poured over 8"x16" footing. Wall thickness shall be a minimum of 4".
- c. Wood Framed – Steps shall be pressure treated 2"x12" stringers shall terminate at slab on grade. Slab Dimensions shall be the width of the stringers and shall extend from the heel of the stringers three feet past the toe to form a landing.
- d. Platform at top of steps shall be 3' x 3' minimum.

7. Concrete Driveway Minimums

4" thick concrete 10' wide. Concrete shall be 2,500 P.S.I. Apron shall be 6" thick with 6"x6" # 10/10 wire mesh. Sidewalks shall be 6" thick at driveway. All concrete shall be broom finished.

H. In the event of any conflict with the above minimum standards, provisions of the Florida Building Code shall take precedence.

Carpentry – General Specifications

Carpentry general specifications shall be governed by the more stringent of the Florida Building Code and the following:

- a. All wood or lumber in contact with concrete, earth or within 12” of grade soil shall be pressure treated.
- b. Furring strips applied to masonry shall be 1” x 2” pressure treated No. 2 yellow pine or equal.
- c. All structural timbers shall be pressure treated No. 2 yellow pine or equal, U.N.O.
- d. Exterior exposed woodwork shall be pressure treated lumber.
- e. All studs shall be stud grade quality or equal.
- f. Interior woodwork and trim shall be ponderosa pine, or clear shop grade pine, or equal. Base trim shall have mitered outside corners, inside corners can be mitered or coped.
- g. All studs shall be 16” on center. All load bearing stud walls shall have double top plates with staggered joints. Hurricane clips shall be installed using Simpson strong tie or equal in quality.
- h. All new and modified construction will conform to the Florida Building Code and the standard for hurricane resistant residential construction.

8. Floor Framing

All new or replaced floor joists shall be no. 2 southern yellow pine, minimum size per code. Floor joists shall be supported at their extreme ends by either a 2”x2” ledger board or appropriate joist hanger. Joists must be continuous without splices.

9. Floor Repair

All damaged, loose or broken sub flooring shall be repaired or replaced before the installation of a finished floor. All end joints should occur over joists. Adjacent end joints shall be staggered. Replaced flooring shall match existing in size quality and finish unless being covered by vinyl, tile, or carpet in which case exterior grade plywood of the same thickness can be used.

10. Exterior Flooring

Tongue and groove flooring shall be 1”x4” grade ‘C’ when used on porches or enclosed utility rooms. Splicing and staggering of joints shall be the same as noted in #9. Floor Repair.

11. Wall Framing

Install exterior plywood or O.S.B. sheathing or diagonally brace with 1"x4" at a 45 degree angle on both sides of new corner posts. New studs in existing or new walls shall be spaced 16" on center. All load bearing stud walls shall have a double top plate with staggered joints. All headers over door and window openings shall be doubled. Appropriate connectors shall be used for all framing per the Florida Building Code.

12. New Stud Walls

Studs shall be 2"x4", 16" on center. Sole plates shall be pressure treated when being installed on concrete slabs. Anchor bolt size and spacing along with washer and bolt size shall conform to the current Florida Building Code.

13. Closet - Clothes

Clothes closets shall be framed using 2"x4" studs, 16" on center. Inside dimensions shall be 2' deep and 4' wide unless specified differently in the work write up. Closets shall be finished inside and out with ½" drywall, base trim, pre-hung hollow core doors or bi-fold doors, clothes shelf and rod. Wire shelving can be used substituting wood shelf and rod.

14. Closet – Linen

Linen closets shall be framed with 2"x4" wood studs 16" on center. Inside dimensions shall be 2' x 2'6". Closet shall be finished inside and out with ½" drywall, base trim, pre-hung hollow core door or bi-fold door, and five shelves. Shelves can be wood or wire.

15. Closet – Heat Unit

Heat unit closet shall be sized to accommodate the heat unit being installed. Closet shall be finished inside with ½" drywall, base trim, pre-hung hollow core door or bi-fold door.

16. Scuttle Hole

Scuttle holes shall be 22"x36" rough opening, trimmed to match existing trim with drywall lid finished to match ceiling finish.

17. Roof Framing

Replace all damaged or deteriorated rafters. When rafter tails are to be replaced, cut them back flush with the exterior siding unless the deteriorated section can be cut off and new wood can be spliced to the good material. New rafter tails shall be the same dimension as the old, attached to the existing rafter by toe nailing and attached to the roof sheathing by nailing through the sheathing to the rafter tail. Sistering tails is also acceptable by extending new material 18" to 24" from the face of the exterior wall into the rake of the existing rafter. All rafters are to be attached to wall framing with the proper connector for the application and uplift.

Collar ties shall be installed on all new rafters or as designated on work write-up for existing rafters. Ties shall be 1"x6" pine or fir and located in the upper third of the rafter.

All angle cut on ties shall be closely fitted to the underside of the sheathing.

When a ridge board is to be installed its minimum thickness shall be 1" and not less in depth than the cut end of the rafter it joins.

Ceiling joists and rafters shall be nailed to each other where the two are in contact.

Ceiling joists shall be continuous or can be spliced over a load bearing wall to provide a continuous tie across the structure.

O.S.B. Roof Sheathing shall be minimum of 4'x8'x1/2" with spacer clips between sheathing. Solid sheathing for repairs shall be the same size as the existing sheathing.

Sheathing supporting barge rafters shall extend a minimum of two trusses or rafters or a minimum of 4'.

Roofing – General Specifications

All roofing shall be applied in conformance with the Florida Building Code. All vents, stacks and chimneys projecting through the roof shall have lead or metal flashing. All damaged or deteriorated sheathing shall be replaced with new. End joints shall be made over a rafter. All existing roofing shall be removed before installing new roofing material. Sheathing attached to barge rafters shall extend back two trusses or rafters but in all cases no less than 4'. Roofing nails shall penetrate through the roof sheathing. When new roofing is installed sagging portions of roof shall be braced with minimum 2"x4" lumber from roof rafter to nearest bearing wall. Purlins or sole plate shall be used when necessary. When a new roof is installed with aluminum fascia, drip edge, gravel stop, and flashing shall be matching aluminum. A roof sheathing inspection is required prior to dry-in.

18. Built-up Roofing

Remove existing roofing material to bare deck. Repair sheathing and rafters where necessary. All new roofing material shall be governed by the Florida Building Code.

19. Shingle Roofing

Remove existing roofing material to bare deck. Repair or replace damaged or deteriorated sheathing and/or rafters. **Install FHA approved flashing and drip edge.** New roofing shall be installed per the Florida Building Code and latest regulatory requirements. Roof shall have a minimum 25-year manufacturers warranty.

20. Mineral Surface Roofing

Remove existing roofing material. Repair or replace damaged or deteriorated sheathing and/or rafters. **Install new flashing and drip edge** and apply mineral surface roofing material per manufacturer's specifications.

21. Granulated Modified – APP - SBS Roofing Material

Remove existing roofing material. Repair or replace damaged or deteriorated rafters and/or sheathing. **Install new flashing and drip edge.** Apply Rubberoid or equal brand according to manufacturer's specifications. Torch down only when safe to do so.

22. Roof Ventilation

Install off ridge venting as specified by the manufacturer and /or work write up. Repair gable vents when necessary by installing new aluminum grills and screening.

23. Lead Boots

All plumbing pipes through roof shall be flashed with lead boots.

Windows – General Specifications

24. Windows

Install new double pane windows, include new aluminum or fiberglass screens. All windows including egress windows shall be single-hung. **(Hinge type swing out windows will not be accepted for egress.)** Window openings shall be framed for standard size windows. New casing and trim shall be installed to match existing. Egress window shall be provided, at least one to each bedroom. All windows shall be caulked and made weather tight. All window installations shall be finished flush as possible to inner and outer wall surfaces.

25. Window Repair

Repairs shall be as specified in the **Work Write Up**. Replace defective window locks. Windows shall operate properly and with ease of movement.

26. New Window Screens

Replace existing screen frames with new aluminum frames and screens complete with new latches and hangers. All old hooks and latches shall be removed and all holes filled. Screens must be in frames and must be removable.

27. Window Screens – Rescreening

Rescreen indicated window screens using 18x4 aluminum mesh or fiberglass. Replace screen molding with new and replace all hooks and hangers. For aluminum framed screens remove spline and screen and install new screen with new spline rolled into frame.

Doors – General Specifications

28. Door Repair

Repairs shall include filling holes and cracks, replacing hardware, lock-sets, and hinges. Exterior door repairs shall include new doorstops with wood mounted weather stripping and aluminum thresholds. Doors shall operate properly without binding. Doors shall be painted according to paint specifications in this manual. When repairing doors the contractor will repair any surrounding area affected by his work. All repairs shall conform to the surrounding surfaces.

29. New Interior Doors

Interior doors shall be 1-3/8" hollow core luan unless specified otherwise in the **Work Write Up**, complete with all hardware. Doors shall be pre-hung units unless otherwise noted. All surrounding areas shall be repaired as needed. Finish and paint as per painting specifications in this manual.

30. New Bi-Fold Doors

Bi-Fold doors shall be hollow core luan doors on slider tracks unless specified otherwise. Provide all hardware including pulls. Finish and paint as per painting specifications in this manual.

31. New Exterior Doors

Exterior doors shall be 1-3/4" pre-hung metal doors with no lites. Doors shall include all hardware including lock-sets and deadbolts keyed alike. Surrounding areas shall be repaired and finished to conform to surrounding surfaces. Doors shall be painted as per the paint specifications in this manual.

32. Sliding Glass Doors

Sliding glass doors as replacements for existing shall be aluminum framed with one or **both sides operable** depending on the function of the existing SGD. Sliding screen is to be included. Surrounding areas shall be repaired and finished to conform to surrounding surfaces.

33. Aluminum Screen Door

Install a 5/8" aluminum pre-hung screen door with two separate screened sections with an aluminum protective grille. Mill finish, white, or bronze finish are acceptable depending on the homeowners choice of colors. All hardware to be included.

34. Wood Screen Door

Install a 1-1/8" wood screen door with two separate screened sections with aluminum protective grille. Doors shall include all hardware and mechanical closer. Doors shall be painted as per the paint specifications in this manual.

Exterior – General Specifications

35. **Exterior Siding – Clapboard, Bevel or Drop**
Install as indicated new wood siding. All joints shall be tight and all joints shall be staggered. Siding shall match existing unless otherwise agreed on by Rehabilitation Specialist.
36. **Exterior Siding T1-11**
Install as indicated new T1-11 siding. Install per manufacturer specifications including any necessary/required barriers. Paint siding as per the paint specifications in this manual.
37. **Exterior Siding – Vinyl**
Install vinyl siding on indicated areas. Siding is to be installed over minimum 6 mil. Vapor barrier or foil faced insulation. J channel inside, outside corners, starter strip, and all molding to finish around doors and windows shall be same manufacturer as siding. Siding and trim shall be installed per manufacturer specifications.
38. **Exterior Finish – Stucco**
Cover indicated areas with stucco finish. Stucco over frame construction shall include a 6 mil. Minimum vapor barrier and metal lath. Metal lath corner bead is to be used around all window and door openings as well as vent openings and termination points. A 3/8" scratch coat and 1/2" finish coat shall be applied. **Texture shall be pre-approved by the rehab specialist upon contractor furnishing sample on site.**
39. **Soffit and Fascia – Aluminum and/or Vinyl**
Soffit area to be level return ventilated material only. Fascia board installed or existing shall be covered with aluminum fascia of matching color. Soffit depth shall be no greater than 16" without support. **Staples shall not be used** for fastening soffit material.
40. **Fascia Repair**
Remove deteriorated sections of wood fascia and replace material suitable for weather exposure.
41. **Wood Soffit – Replacement or Repair**
Install min. 3/8" exterior grade plywood to eave area. Plywood shall be flush with face wall of structure and butt to inside of fascia board. Soffit shall be at a 90° angle to face wall. Soffit shall be finished at the wall with molding. Fascia board attached to rafter tails at end cut shall be 1" x material or 2" x material depending on application and shall be indicated on work write up or pre-approved by the rehab specialist. Fascia material shall be approved for weather exposure. Ventilation shall be provided by using screen wire secured over 4" or 6" wide continuous opening or when matching existing conform to width.
42. **Leaders and Gutters**
Where required, aluminum or galvanized gutters shall be installed over existing fascia or backstops with hangers as per manufacturer's specifications. **Include concrete splash pads** at all termination points of leaders.

Insulation – General Specifications

43. Insulation

Ceiling Insulation shall be Johns-Manville or equal and shall provide a minimum R-19 rating or as specified in the Work Write Up. Provide a 1" air space between roof decking and insulation baffle around perimeter of attic. All insulation shall be installed as per manufacturer recommendations and shall comply with the Florida State Energy Code.

Ceiling and Wall – General Specifications

44. Ceiling Finish – Drywall

Ceilings shall be 5/8" drywall. All joints, shall be taped and finished per manufacturer specifications and **Work Write Up**. All nails and/or screws shall be finished with drywall compound and sanded. Drywall shall be applied directly to ceiling framing unless otherwise specified in the work-write-up. Drywall shall be secured as per code.

45. Drop Ceiling – Drywall

Ceiling shall be 5/8" drywall finished according to manufacturer specifications and **Work Write Up**. Drywall shall be secured to new 2"x4" ceiling joists spaced max 24" on center. New joists shall be secured to existing and shimmed to obtain flat surface.

46. Ceiling Finish – Popcorn

Spray application of popcorn finish shall be done according to manufacturer's specifications. An even and consistent finish is expected.

47. Ceiling Finish – Knock-Down

Spray application of knock-down finish shall be done according to manufacturers specifications. An even and consistent finish is expected.

48. Ceiling and Wall Finish – Veneer Plaster

On existing plaster, fill all cracks and holes with non-shrinking filler. Apply stain retardant as needed. Apply bonding agent and veneer plaster (rough or smooth texture). Finished surface shall be uniform in texture and color.

49. Ceiling and Wall Finish – Drywall

On existing drywall repair all holes and damage to surface. All blow out patches and repairs shall be finished to match existing finish.

50. Wall Finish Drywall

Apply new 1/2" drywall to existing studs. All joints taped and finished per manufacturer specifications. All nail and/or screws shall be finished with drywall compound and sanded smooth along with all joints.

51. Wall Finish Knock-Down

Spray application of knock-down finish shall be done according to manufacturers specifications. An even and consistent finish is expected.

52. Wall and Ceiling Finish ¼” Drywall

Laminate existing ceilings and/or walls with ¼” drywall. Drywall on ceiling shall be glued and secured with fasteners according to code. Drywall on wall needs only fasteners installed according to code. Finish as per all drywall specifications.

53. Wall Finish – Paneling

Installation of paneling shall include matching inside and outside corner trim, window and door trim, cover molding and base trim. When installing in conjunction with new windows, paneling shall return to window frames. Window sills shall be as specified in the **Work Write-Up**. Method of installation shall adhere to manufacturer specifications.

Painting – General Specifications

54. Painting

All paint work shall be governed as per **Painting – General Appendix P**

Each coat of paint is to be inspected by the Rehabilitation Specialist. Please notify the Rehabilitation Specialist for your painting inspection.

Cabinets - General Specifications

55. Cabinets – Medicine

Install a standard size recessed three shelf mirrored medicine cabinet centered over the lavatory.

56. Cabinet – Vanity

Lavatory base cabinets shall be ½” AC plywood or high-density board, 24” wide. Formica finish with doors unless specified otherwise. Cultured marble tops with molded sink, backsplash at all walls.

57. Cabinet – Base

Base cabinets shall be ½” AC plywood or high density board with formica finish unless specified otherwise. Doors, drawers, pulls, and shelves are to be included along with toe kick of the same material and finish. Caulk all joints where necessary.

58. Cabinets – Wall

Wall cabinets shall be ½” AC plywood or high density board with formica finish unless specified otherwise. Doors, pulls, and shelves are to be included. Caulk all joints where necessary.

59. Counter Top

Counter tops shall be approximately 25” deep with a minimum 4” back splash. Tops shall be fitted to cabinets. Finish shall be formica with all edges finished unless specified otherwise.

Bathroom – General Specifications

60. Wall Finish Ceramic Tile

Remove existing materials on indicated walls. Apply ceramic tile to new concrete tile backer (Such as Dura-Rock or Wonderboard). Trim edges with bull-nose tile. Wall tile shall be a minimum standard grade 4"x4"x1/4".

61. Ceramic Fixture Set

Install paper holder, toothbrush holder, two towel bars and a soap dish. Do not locate towel bars over paper holder.

62. Grab Bars

Install two 24" x1-1/2" stainless steel grab bars. One horizontally in the tub area and the other installed adjacent to the water closet (34" to 38" above the floor.) Walls shall include solid wood backing for securing grab bars.

Flooring – General Specifications

63. Flooring Underlayment

Underlayment shall be hardboard or plywood labeled as underlayment grade by the manufacturer. Thickness shall be designated in work write up. Fill all cracks, joints, and holes with appropriate compound suitable for such use.

64. Floor Covering – Tile

Install underlayment grade hardboard 1/4" thickness. Install 3/32" vinyl tile using adhesive recommended by the manufacturer. When installing new floor covering shoe molding shall be installed or replaced with new and finished according to the paint specifications in this manual.

65. Floor Covering – Sheet Vinyl

Install underlayment grade hardboard 1/4" thickness. Install sheet vinyl .090 gauge minimum over underlayment. Install using manufacturer's specifications. Shoe molding shall be installed or replaced with new and finished according to the paint specifications in this manual.

66. Floor Covering – Carpet

Repair all cracks, holes and soft areas in existing flooring. Install high-density 9/16" or equal padding. Install carpeting compete with jute or olefin backing only.

67. Base Trim

Shoe molding is to be used for vinyl and tile floors unless otherwise designated in work write up. Colonial or clamshell base trim is to be used for carpeted floors. All base trim must match and all inside corners shall be coped and all outside corners shall be mitered.

Vinyl cove molding is to be used in bathrooms unless otherwise designated in work write up. All wood trim is to be finished according to the paint specifications in this manual.

Appliances – General Specifications

68. Appliances

Install specified appliances per manufacturer's specifications and test for proper operation.

Ranges –to include oven window, clock with timer and electronic ignition for gas ranges.

Refrigerators – are to be two door and frost-free.

69. Range Hoods

Shall be ducted or ductless according to work write up. Finish shall match the color of the appliances.

Systems – General Specifications

70. Mechanical Equipment Repair

All equipment such as ranges, refrigerators, range hoods, heating and cooling equipment etc., shall be repaired and tested to assure safety and operation along with durability.

Heating -- All heaters will conform to applicable codes.

71.

A. Gas – Indicated model shall be installed in area designated, to include blower system and tested for proper operation. No unvented gas heaters shall be accepted. All gas heaters shall meet with standard national approval and labeled by the National Gas Association. Size shall be determined by the Rehabilitation Specialist and must be test fired before final inspection. Contractor is responsible for all tank or meter installation fees and gas line installation fees. The contractor is not responsible for gas deposits.

B. Electric – Indicated models shall be installed in area designated and tested for proper operation. Individual heaters shall be on separate circuits as per the National Electrical Code. All electric heaters shall be equipped with forced air operation installed as per manufacturer's recommendations, and labeled a U.L. approved appliance.

72. Electrical

All work shall conform to the latest adopted edition of the **National Electrical Code**.

Installation of new or repair of electrical components shall not weaken or destroy any structural members of the building unit. All drilling, cutting, or altering to facilitate the installation/ repair of electrical work will require replacement/ patchwork to restore the areas affected to their original condition.

All electrical fixtures and devices shall be U.L. approved.

All light fixtures shall come equipped with the appropriately sized bulbs for that fixture and shall be of the **energy mizer** designation or similar approval. Spare bulbs for each fixture shall be included in the bid for future use by the owner.

Electrical services shall be a minimum 150A and shall be sized to include a minimum of 2 spare circuits.

All appliances shall be on separate circuits as dedicated circuits.

Dishwashers shall utilize plug and cord disconnect.

Smoke detectors shall be provided and installed per NFPA 72. (110v. and battery back-up)

73. Plumbing

All plumbing shall comply with the latest adopted edition of the **Florida Building Code-Plumbing**.

Installation of new plumbing/ repair work shall not weaken or destroy any structural portion of the building unit. Any cutting, drilling, alteration to facilitate the installation of plumbing will require replacement/ patching to restore the affected areas.

All tubs, sinks, lavatories, water heaters and/or water closets when provided shall be installed complete.

Showers shall include shower rods unless otherwise specified in the **work write-up**.

All appliances shall include **energy star** or similar energy **efficiency ratings**.

- A. Electric water heaters** shall be installed complete with pan, electrical disconnect, and pressure relief line to the outside of the building and shall provide a minimum **7 year warranty**.
- B. Gas water heaters** shall be installed complete with gas shut-off and be properly vented. No gas appliance unit shall be installed in bedrooms.
- C. Washing machines** shall be installed with adequate access space to utilize and be installed with hammer arrestor to code.
- D. Tubs** shall be a minimum 5' porcelain on steel , installed with shower rod.
- E. Shower base/ drain** shall be one piece acrylic/ fiberglass units unless noted otherwise
- F. Tub Fixtures** shall be replaced with each tub replacement unless otherwise noted, equipped with ant-scald device, bath filler, and shower head (Heritage or equal)
- G. Vanity Lavatory** shall be one piece cultured marble with backsplash on all walls
- H. Water Closet** shall be of water saver type American Standard Cadet model or equal.
- I. Sewer** – Trench and lay 4" PVC schedule 40 sewer pipe per code. Make complete connections at street stub-up and at dwelling with appropriate clean-outs.
- J. Septic Tank** - Abandon tank. Pump tank and punch hole in bottom, fill with sand. Documentation of tank abandonment shall be provided.

- K. Water line** – Trench to minimum 12” depth. Provide and install Min. ¾” schedule 40 PVC line, connect to water meter and dwelling per all applicable codes. Install anti-siphon devices for all required hose bib locations.

- L. Kitchen sink** – Replace with two compartment stainless steel sink, ledge mounted ,swing spout faucet, stainless steel strainer, and all necessary fittings

Pest Extermination – General Specifications

74. Pest Extermination

- A. When termite treatment is specified, all structures on property are to be treated. The “treatment” shall be that treatment recommended by a bonded, licensed exterminator to rid the structures of any and all types of termites and shall carry a minimum warranty of one (1) year.
- B. Other treatment as specified.

Chemicals used shall be those that will cause the least inconvenience to the property owner (moving of foam rubber articles, plants, etc.)

Any damage to the structure, interior or exterior, or to the property (plants, etc.) caused by termite treatment, shall be repaired or replaced by the contractor. Pest extermination is considered to be a subcontract through the general contractor.

Construction Debris – General Specifications

75. Construction Debris

Construction debris shall be removed from the premises and hauled away to an approved dump-site before calling for a final inspection. Site shall be left clean.

A.D.A. REQUIRMENTS

This section is to be used only as a guide for estimating jobs. The actual A.D.A. Code shall be used for all specifications.

HANDRAILS, GRAB BARS AND TUB AND SHOWER SEATS

General

All handrails, grab bars and tub and shower seats required to be accessible.

Size and Spacing of Grab Bars and Handrails

The diameter or width of the gripping surfaces of a handrail or grab bar shall be 1-1/4 to 1-1/2 in (32 mm to 38 mm), or the shape shall provide an equivalent gripping surface. If handrails or grab bars are mounted adjacent to a wall, the space between the wall and the gripping surface shall be 1-1/2 in (38 mm) [See Fig. 39(a), (b), (c), and (e)]. Handrails may be located in a recess if the recess is a maximum of 3 in (75 mm) deep and extends at least 18 in (455 mm) above the top of the rail [see Fig 39 (d)].

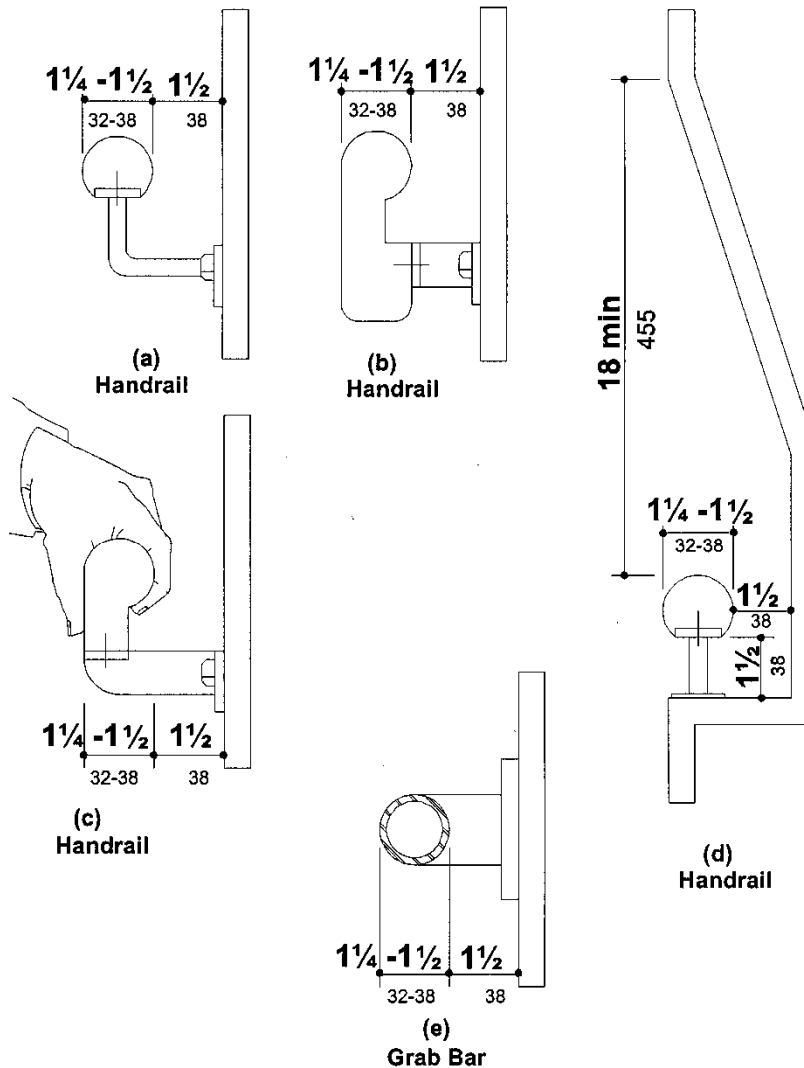

Fig. 39
Size and Spacing of Handrails and Grab Bars

Ramps

General

Any part of an accessible route with a slope greater than 1:20 shall be considered a ramp.

Slope and Rise

The least possible slope shall be used for any ramp. The maximum slope of a ramp in new construction shall be 1:12. The maximum rise for any run shall be 30 in (760 mm) (see Fig. 16). Curb ramps and ramps to be constructed on existing sites or in existing buildings or facilities may have slopes and rises if space limitations prohibit the use of a 1:12 slope or less.

(1) The landing shall be at least as wide as the ramp run leading to it.

(2) All landings on ramps shall be not less than 60 inches clear, and the bottom of each ramp shall have not less than 72 inches of straight and level clearance.

(3) If ramps change direction at landings, the minimum landing size shall be 60 in by 60 in (1525 mm by 1525 mm).

Handrails

If a ramp run has a rise greater than 6 in (150 mm) or a horizontal projection greater than 72 in (1830 mm), then it shall have handrails on both sides. Handrails are not required on curb ramps.

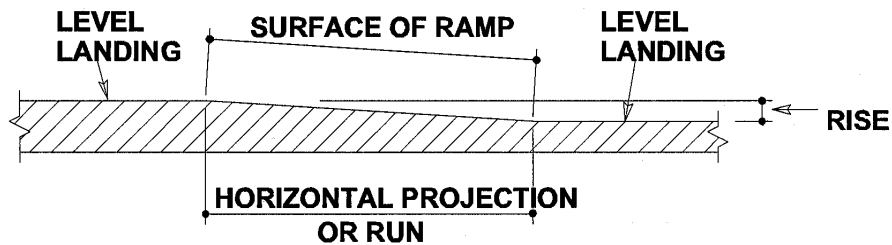

SLOPE	MAXIMUM RISE		MAXIMUM HORIZONTAL PROJECTION	
	IN	MM	FT	M
1:12 TO < 1:16	30	760	30	9
1:16 TO < 1:20	30	760	40	12

Fig. 16 - Components of a Single Ramp Run and Sample Ramp Dimensions

Clear Width

(1) The minimum clear width of a ramp shall be 36 in (915 mm).

(2) Ramps that are part of a required means of egress shall be not less than 44 inches wide.

Landings

Ramps shall have level landings at bottom and top of each ramp and each ramp run. Landings shall have the following features.

Handrails shall have the following features:

(1) Handrails shall be provided along both sides of ramp segments. The inside handrail on switchback or dogleg ramps shall always be continuous.

(2) Handrails on ramps which are not continuous shall extend not less than 18 inches beyond the sloped segment at both the top and bottom, and shall be parallel to the floor or ground surface (see Fig. 17).

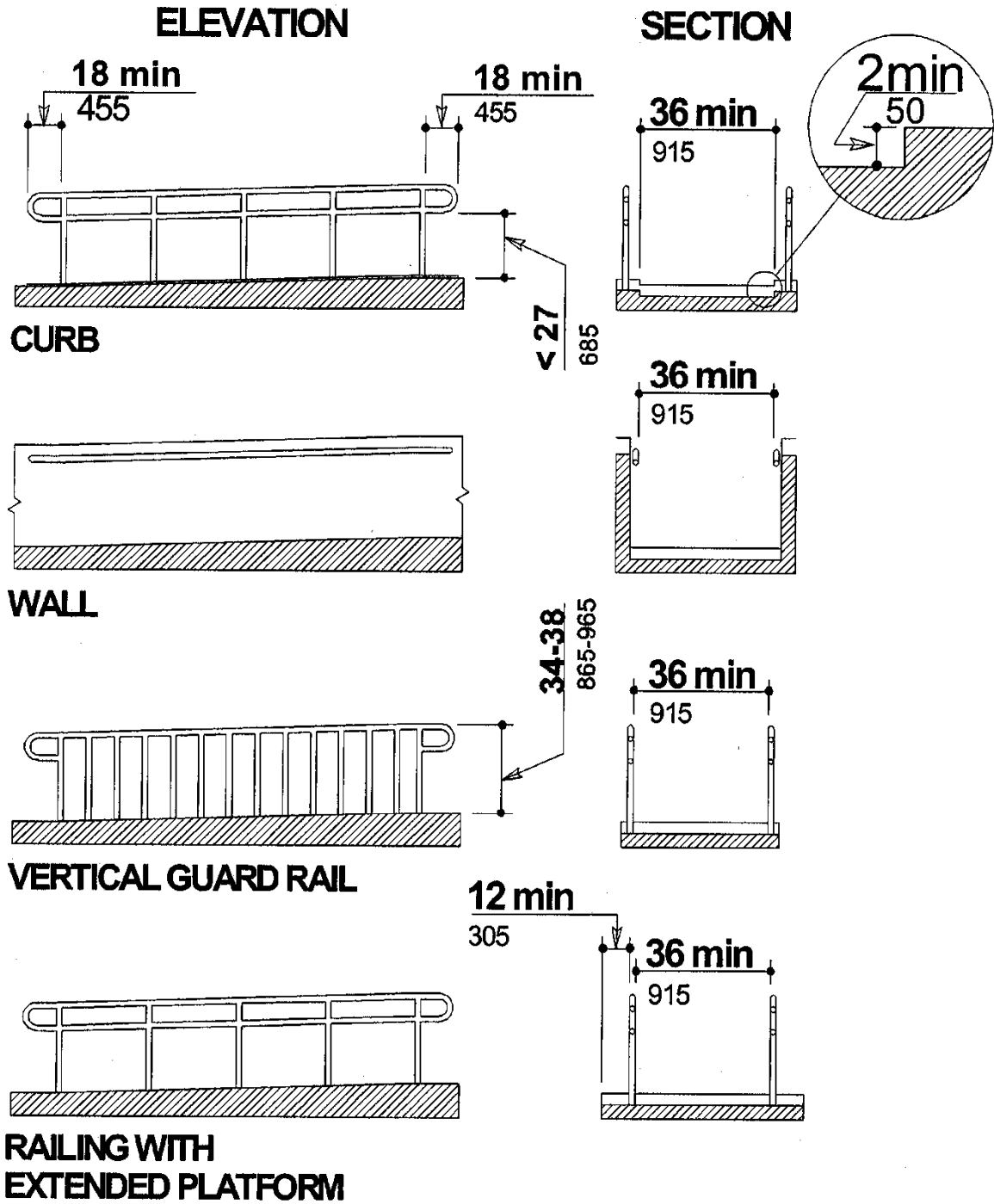

**Examples of Edge Protection and Handrail Extensions
Fig. 17**

- (3) The clear space between the handrail and the wall shall be 1-1/2 in (38 mm).
- (4) Gripping surfaces shall be continuous.
- (5) Top of handrail gripping surfaces shall be mounted between 34 in. and 38 in. (865 mm and 965 mm) above ramp surfaces.
- (6) Ends of handrails shall be either rounded or returned smoothly to floor, wall or post.
- (7) Handrails shall not rotate within their fittings.

Cross Slope and Surfaces

The cross slope or ramp surfaces shall be no greater than 1:50.

Edge Protection

Ramps and landings with drop-offs shall have curbs, walls, railings or projecting surfaces that prevent people from slipping off the ramp. Curbs shall be a minimum of 2 in. (50 mm) high (see Fig. 17).

Outdoor Conditions

Outdoor ramps and their approaches shall be designed so that water will not accumulate on walking surfaces.

STAIRS

Treads and Risers

On any given flight of stairs, all steps shall have uniform riser heights and uniform tread widths. Stair treads shall be no less than 11 in. (280 mm) wide, measured from riser to riser [see Fig. 18(a)]. Open risers are not permitted.

Nosings

The undersides of nosings shall not be abrupt. The radius of curvature at the leading edge of the tread shall be no greater than 1/2 in (13 mm).

Risers shall be sloped or the underside of the nosing shall have an angle not less than 60 degrees from the horizontal. Nosings shall project no more than 1-1/2 in (38 mm) (see Fig. 18).

Handrails

Stairways shall have handrails at both sides of all stairs.

- (1) Handrails shall be continuous along both sides of stairs. The inside handrail on switchback or dogleg stairs shall always be continuous [see Fig. 19(a) and (b)].
- (2) If handrails are not continuous, they shall extend at least 12 in. (305 mm) beyond the top riser and at least 12 in (305 mm) plus the width of one tread beyond the bottom riser. At the top, the extension shall be parallel with the floor or ground surface. At the bottom, the handrail shall continue to slope for a distance of the width of one tread from the bottom riser; the remainder of the extension shall be horizontal [see Fig. 19 (c) and (d)]. Handrail extensions shall comply with 4.4.
- (3) The clear space between handrails and wall shall be 1-1/2 in. (38 mm).
- (4) Gripping surfaces shall be uninterrupted by newel posts, other construction elements, or obstructions.
- (5) Top of handrail gripping surface shall be mounted between 34 in. and 38 in (865 mm and 965mm) above stair nosing.
- (6) Ends of handrails shall be either rounded or returned smoothly to floor, wall or post.
- (7) Handrails shall not rotate within their fittings.

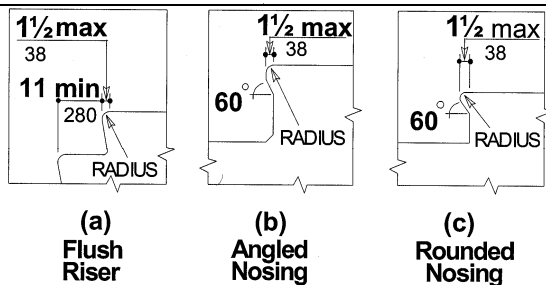

← **Fig. 18 - Usable Tread Width and Examples of Acceptable Nosings**

LAVATORIES

Exposed Pipes and Surfaces

Hot water and drain pipes under lavatories shall be insulated or otherwise configured to protect against contact. There shall be no sharp or abrasive surfaces under lavatories.

Faucets

Accessible lavatories shall have lever-operated faucets and narrow aprons which shall be mounted at a vertical distance of 28 inches, measured by the vertical distance from the finished surface of the floor to the bottom of the apron, and which shall allow for use of the lavatory by persons in wheelchairs [see Fig. 31 (b)].

If self-closing valves are used, the faucet shall remain open for at least 10 seconds.

Height and Clearances

Lavatories shall be mounted with the rim or counter surface no higher than 34 in (865 mm) above the finish floor. Provide a clearance of at least 29 in (735 mm) above the finish floor to the bottom of the apron. Knee and toe clearance shall comply with Fig. 31 (a).

Mirrors

Mirrors shall be mounted with the bottom edge of the reflecting surface no higher than 40 in (1015 mm) above the finish floor [see Fig. 31 (a)].

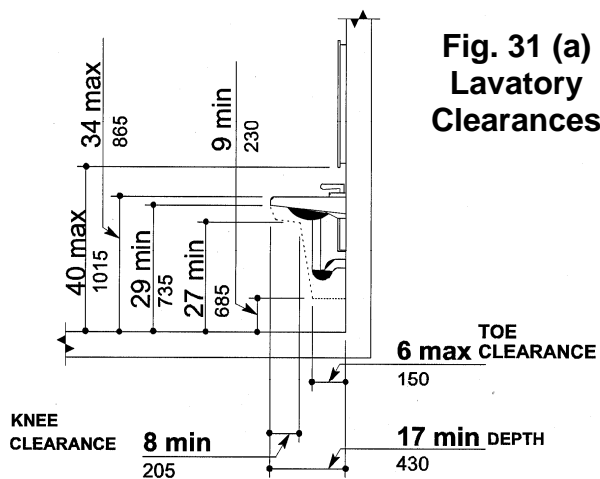

BATHTUBS

Floor Space

Clear floor space in front of bathtubs shall be as shown in Fig. 33.

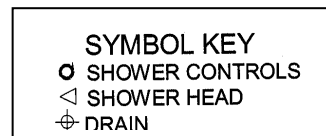
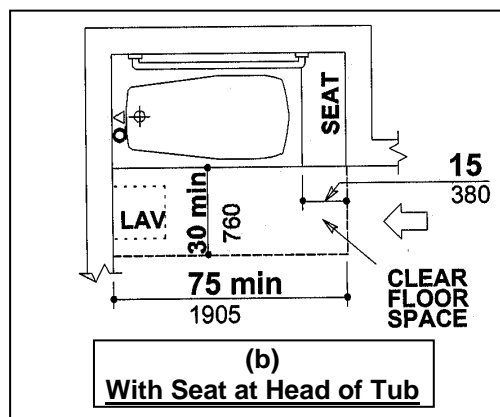
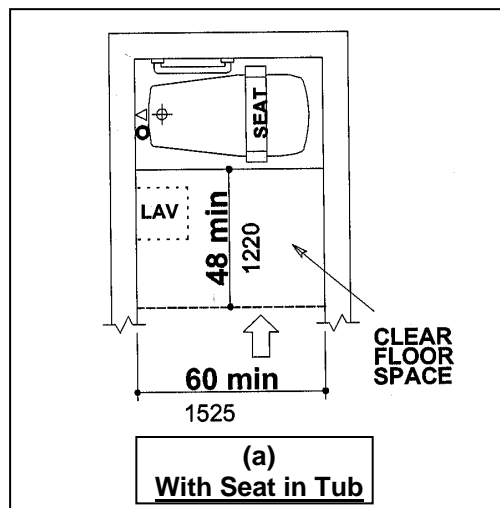
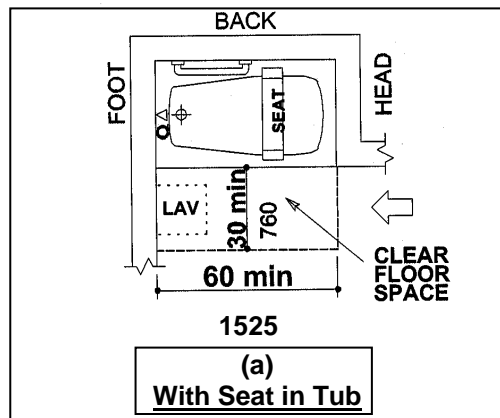

Fig. 33
Clear Floor Space at Bathtubs

Seat

An in-tub seat or a seat at the head end of the tub shall be provided as shown in Fig. 33 and 34.

Grab Bars

Shown in Fig. 33 and 34.

Controls

Faucets and other controls shall be located as shown in Fig. 34.

Shower Unit

A shower spray unit with a hose at least 60 in. (1525 mm) long that can be used both as a fixed shower head and as a hand-held shower shall be provided.

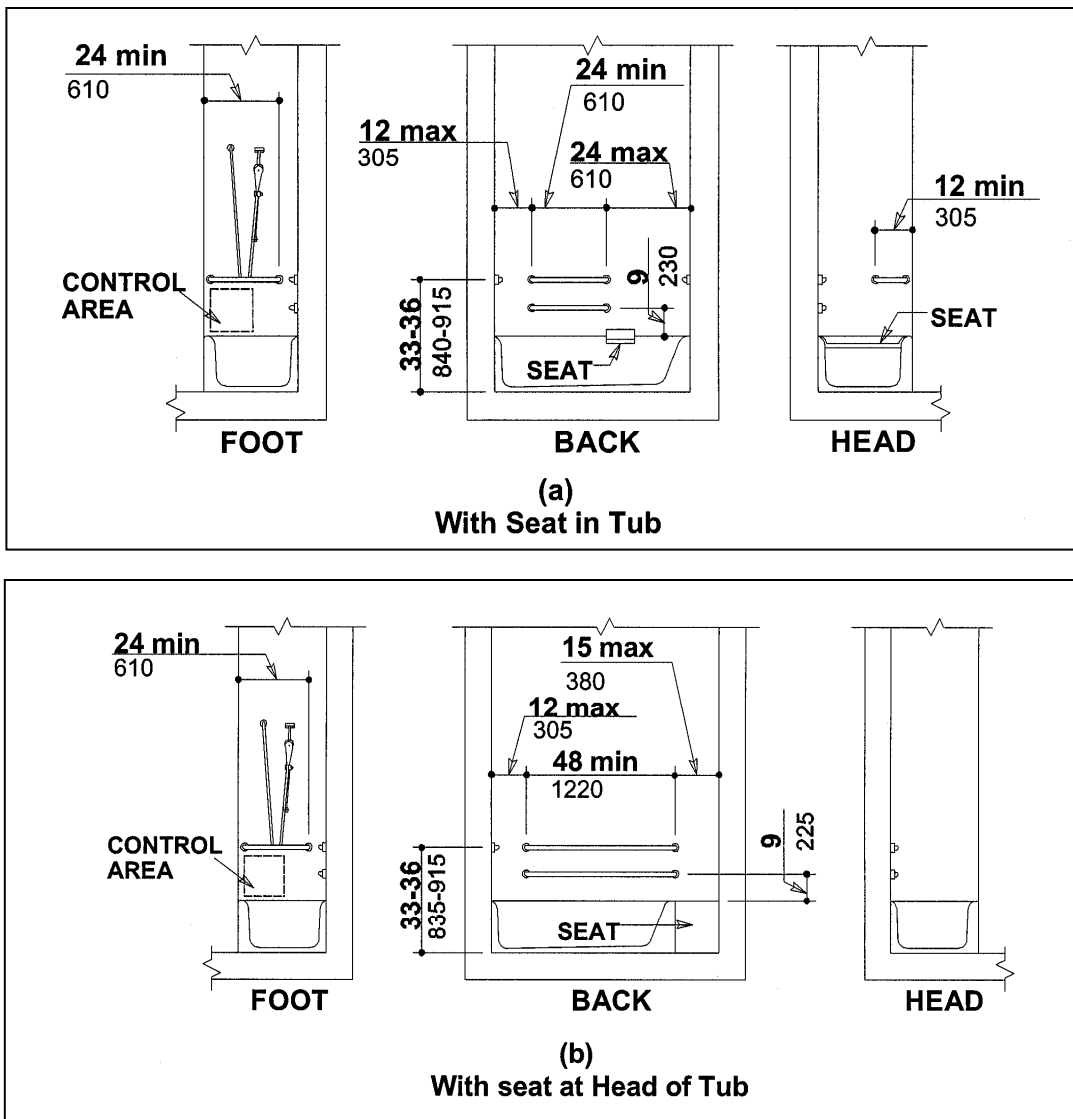

**Fig. 34
Shower Size and Clearances**

Bathtub Enclosures

If provided, enclosures for bathtubs shall not obstruct controls or transfer from wheelchairs onto bathtub seats or into tubs. Enclosures on bathtubs shall not have tracks mounted on their rims.

SHOWER STALLS

Size and Clearances

The shower stall size and clear floor space shall comply with Fig. 35(a) or (b). The shower stall in Fig. 35(a) shall be 36 in. by 36 in. (915 mm by 915 mm).

The shower stall in Fig. 35(b) will fit into the space required for a bathtub.

Seat

A seat shall be provided in shower stalls 36 in. by 36 in. (915 mm by 915 mm) and shall be as shown in Fig. 36. The seat shall be mounted 17 in. to 19 in. (430 mm to 485 mm) from the bathroom floor and shall extend the full depth of the stall. In a 36 in. by 36 in. (915 mm by 915 mm) shower stall, the seat shall be on the wall opposite the controls. Where a fixed seat is provided in a 30 in. by 60 in. minimum (760 mm by 1525 mm) shower stall, it shall be a folding type and shall be mounted on the wall adjacent to the controls as shown in Fig. 57. The structural strength of seats and their attachments shall comply with 4.26.3.

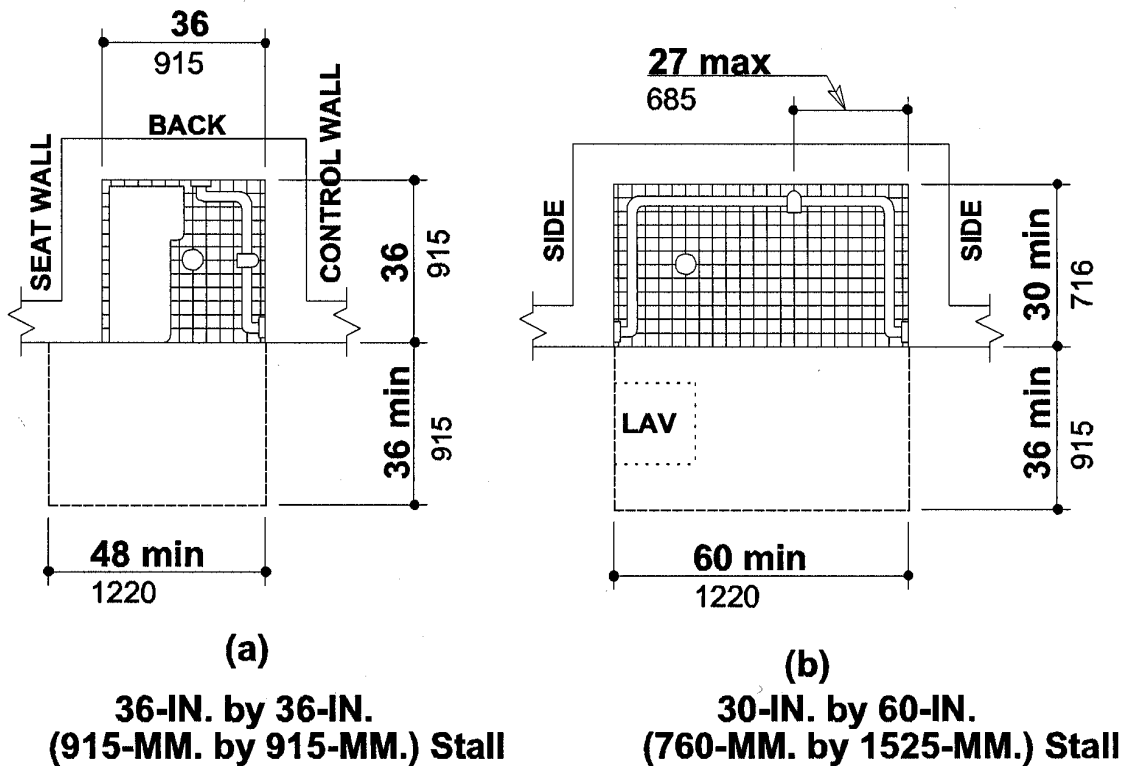

Fig. 35
Shower Size and Clearances

Structural Strength

The structural strength of grab bars, tub and shower seats, fasteners, and mounting devices shall meet the following specifications:

- (1) Bending stress in a grab bar or seat induced by the maximum bending moment from the application of 250 lbf (1112N) shall be less than the allowable stress for the material of the grab bar or seat.
- (2) Shear stress induced in a grab bar or seat by the application of 250 lbf (1112N) shall be less than the allowable shear stress for the material of the grab bar or seat. If the connection between the grab bar or seat and its mounting bracket or other support is considered to be fully restrained, then direct and torsional shear stresses shall be totaled for the combined shear stress, which shall not exceed the allowable shear stress.
- (3) Shear force induced in a fastener or mounting device from the application of 250 lbf (1112N) shall be less than the allowable lateral load of either the fastener or mounting device or the supporting structures, whichever is the smaller allowable load.
- (4) Tensile force induced in a fastener by a direct tension force of 250 lbf (1112N) plus the maximum moment from the application of 250 lbf (1112N) shall be less than the allowable withdrawal load between the fastener and the supporting structure.
- (5) Grab bars shall not rotate within their fittings.

Eliminating Hazards

A handrail or grab bar and any wall or other surface adjacent to it shall be free of any sharp or abrasive elements. Edges shall have a minimum radius of 1/8 in. (3.2 mm).

Controls

Faucets and other controls shall be located as shown in Fig. 37. In shower stalls 36 in. (915 mm by 915 mm), all controls, faucets and the shower unit shall be mounted on the side wall opposite the seat.

Shower Unit

A shower spray unit with a hose at least 60 in. (1525 mm) long that can be used both as a fixed shower head and as a hand-held shower shall be provided.

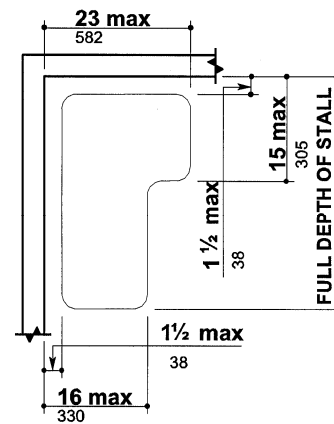
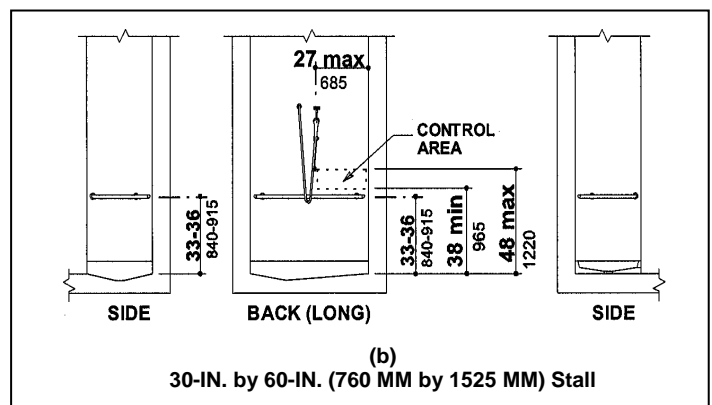
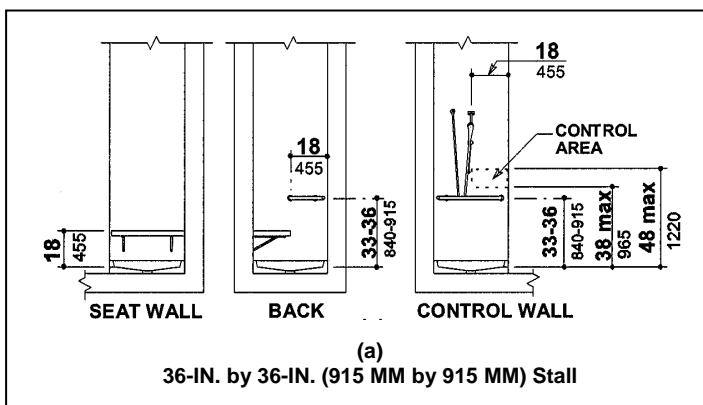

Fig. 36
Shower Seat Design



NOTE: Shower head and control area may be on back (long) wall (as shown) or on either side wall

Fig. 37
Grab Bars and Shower Stalls

Lead-Based Paint Maintenance Planning Tool

INTRODUCTION

This Lead-Based Paint Maintenance Planning Tool is a guide designed for you to develop a custom fit checklist to conduct lead-based paint maintenance activities in a safe manner.

- **Lead Job Check List** – Use the job checklist to help you recognize risky activities; plan and perform your work; and protect yourself, fellow workers, the residents, and your family from lead hazards.
- **Materials** – Identify the materials (disposables) needed for the particular job by circling the picture of words.
- **Equipment** – Circle the equipment needed for the particular job.
- **Personal Protection** – Assign the protection the worker will need by circling the picture or words.
- **Work Practices** – Circle the work practices that are appropriate to the task.
- Prohibited and Unsafe Practices – Avoid these practices that jeopardize the health and safety of workers and residents.
- **Cleanup** – Circle the cleanup practices appropriate to the job. As tasks are completed by the worker, the work practices are checked-off as used. For example, when you plan, circle “tape”, when you use it, cross it off.
- **Carpet Removal** – Follow the different work practices required for this commonly performed activity.
- **Decontamination** – Circle practices that are appropriate to the job.
- **Quality Assurance** – When the job is finished, do a “protecting” check. The job is complete when you can answer all of the questions by circling “Yes” or “NA” (not applicable).

LEAD JOB CHECKLIST

Resident Name: _____ Job # _____

Phone: _____ Address/Apt. # _____

1. Was the building built before 1978?

If you don't know when the building was built, treat the paint as lead-based paint. If the building was built after 1978, then lead-based paint is probably not present and this is not a lead job.

2. Could this job:

Create lead dust that may contain lead?	Yes	No
Disturb known or suspected lead-based paint?	Yes	No
Require cleanup of dust or debris that may contain lead?	Yes	No
Disturb known or suspected lead contaminated soil?	Yes	No

3. If "Yes" to any of the above, or if you don't know the answer to any of the questions, assume you are dealing with lead-based paint, and circle the level of risk below.

Low Risk =

- Low levels of dust expected to be generated, and
- surface and paint in good condition, and
- less than two (2) square feet.

High Risk =

- High levels of dust expected to be generated, or
- surface and paint in poor condition, or
- greater than two (2) square feet.

4. Who will do the job? *Personnel must be properly trained and skilled. If they will have to wear a respirator, they must be medically qualified, fit-tested, and trained.*

5. How will residents be notified and affected?

Notification: Phone _____ Letter _____ Time _____ Date _____

Work area instructions to residents:

Job scheduled: FROM: Time/Date _____ TO: Time/Date _____

Resident asked to leave unit: FROM: Time/Date _____ TO: Time/Date _____

Resident asked to move personal items? Yes No

Temporary accommodation needed for resident? Yes No

If "Yes" accommodation provided? Yes No

If "Yes", WHERE _____ PHONE# _____

6. How will work be performed to minimize exposure to lead? *Circle specific cards to use for this job:*

Materials Card	Work Practices Card	Carpet Removal Card
Equipment Card	Prohibited and Unsafe Practices	Decontamination Card
Personal Protection Card	Cleanup Cards	Quality Control Card

MATERIALS

*Circle needed materials (*Note:  for high risk)*



Poly Film – 6 mil polyethylene plastic or equivalent)



Poly Bags – 6 mil



Tape



Towelettes



All-Purpose Cleaner, or cleaner made specifically for lead



Tack Pads



Rags



String Mop Heads

Circle needed equipment.



Spray Mister

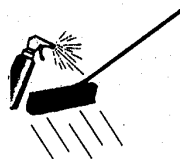

Broom (Wet Sweep Only)



Mop Handles

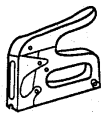

Stapler



Dust Pan (Wet Sweep Only)

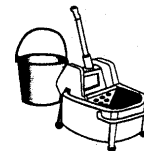

Buckets



Scrapers



HEPA Vacuum

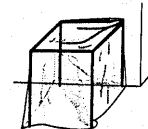

Mini Containment



Utility Knife

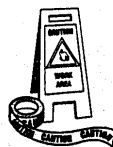

Signs/ Barrier Tape

PERSONAL PROTECTION

Circle needed protection



Protective Eye Wear



Latex/Rubber Gloves

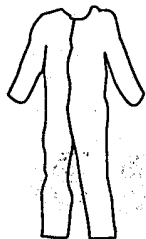

Coveralls



Disposable Cotton



Disposable Full-Body Coveralls
Recyclable Clothing

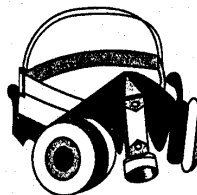

Respirators
W/HEPA Filters

WORK PRACTICES

Circle needed work practices (*Note ↑ for high risk)

WORK SMART



Protect and inform residents.

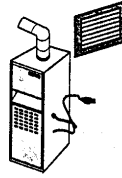

Shutdown HVAC and/or isolate vents.

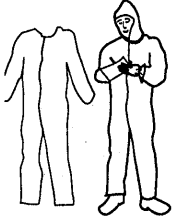

Wear proper personal protective clothing.

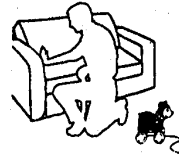

Remove/protect resident Belongings.



Be alert to special situations.



Install 6 mil poly film securely.



Isolate area with 6 mil film.



WORK WET

Mist work area with water.



Install catch bag under work area.



Wet scrape, sand, pry, saw, plane, drill, and remove painted materials.



Keep debris picked up.

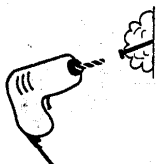

“Foam” drilling area.



Control settled dust.

WORK CLEAN



Use tack pad.

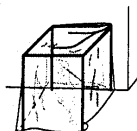

Use mini containment.

PROHIBITED PRACTICES



**NO MECHANICAL
GRINDING/SANDING
WITHOUT HEPA ATTACHMENTS**

**NO ABRASIVE OR
WATER BLASTING**



**NO:
OPEN FLAME BURNING,
HEAT GUN HOTTER THAN 1,100°F
WELDING/FLAME CUTTING**



**NO METHYLENE
CHLORIDE-BASED
STRIPPERS**

**NO EXTENSIVE
DRY SCRAPING**



UNSAFE PRACTICES



**NO VACUUMING WITH
HOUSEHOLD VACUUM**

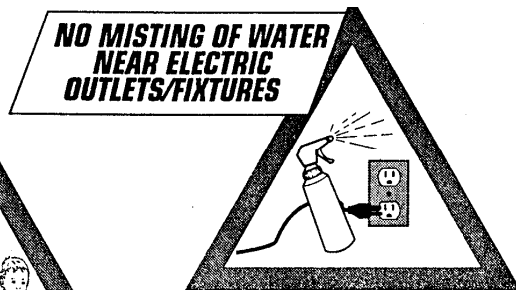

**NO MISTING OF WATER
NEAR ELECTRIC
OUTLETS/FIXTURES**

**NO WASHING IN
RESIDENT'S SINK OR
LAVATORY**

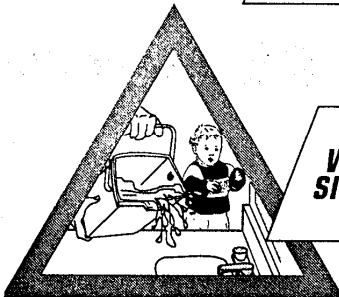
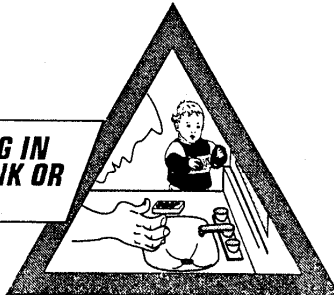

**NO DISPOSAL OF
WATER IN RESIDENT
SINKS/BATHTUBS OR
YARD AREAS**



**NO DISPOSAL OF
WASTE IN RESIDENT
TRASH**

CLEANUP - LOW RISK

1.



Place large debris in 6 mil poly bags.

7.

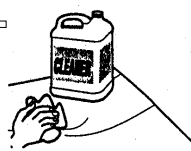

Wet wipe with cleaner under and 2' beyond area that was covered with poly film.

2.



Wet wipe tools.

8.

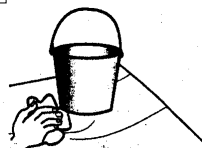

Rinse wipe with water under and 2' beyond area that was covered with poly film.

3.



Mist debris on work area poly film.

9.



Gooseneck seal and label 6 mil poly bag.

4.



Fold poly film "dirty side in". Place in poly bag and label.

10.



Remove all materials, tools and bagged debris from work area and residence.

5.

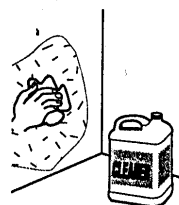

Wet wipe work area with cleaner.

11.



Properly dispose of bagged debris.

6.

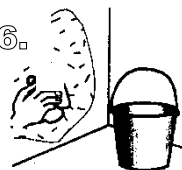

Rinse work area with water.

CLEANUP - HIGH RISK

1.



Place large debris in 6 mil poly bags. ↑

2.



Place contaminated tools/equipment in poly bag and seal. ↑

3.

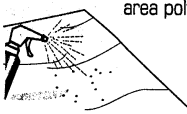

area poly film

Mist small debris on work area poly film. ↑

4.

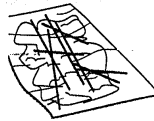

Remove mini containment and place on poly film. ↑

5.



Properly remove coveralls. Place disposable type on poly film or recyclable type in Laundry bag.

6.



Fold poly film "dirty side in". Place in poly bag and label. ↑

7.



Wet wipe with cleaner the area that was repaired. ↑

8.



Rinse work area with water.

9.

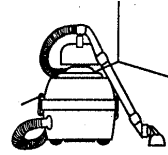

HEPA vac under and 2' beyond Area that was covered with poly film. ↑

10.



Wet mop with cleaner under and 2' beyond area that was covered with poly film. Wring mop in separate bucket. ↑

11.



Rinse mop with water under and 2' beyond area that was covered with poly film. Wring mop in separate bucket. ↑

12.

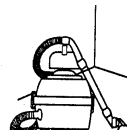

HEPA vac under and 2' beyond area that was covered with poly film again. ↑

13.



Gooseneck seal and label 6 mil poly bag. ↑

14.



Remove all materials, tools and bagged debris from work area and residence. ↑

15.



Properly dispose of bagged debris. ↑

CARPET REMOVAL

Circle needed work practices.

CARPET



1. Mist carpet.

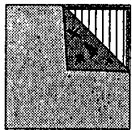

2. Loosen wall to wall from tack strips or areas.



3. Cut carpet to manageable portions with utility knife. (about every 6 feet)

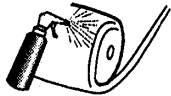

4. Roll carpet "pile side in" while misting carpet backing.

PAD



5. Cut padding to manageable portions with utility knife.

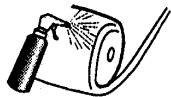

6. Roll pad while misting.



7. Wrap carpet & padding in 6 mil poly, seal with tape, and remove from area.

FLOOR

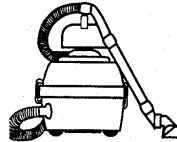

8. HEPA vac floor area.

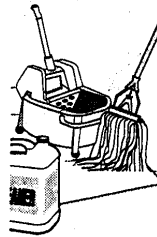

9. Wet mop floor area, and baseboards with cleaner.



10. Rinse mop floor area and baseboards.

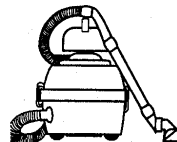

11. HEPA vac floor area again.

DECONTAMINATION

Circle needed work practices

PERSONAL



Vacuum clothing with vacuum.



Shower with soap.



Wipe hands and face towelettes.



Send recyclable coveralls to the special laundry.

or



Wash face and hands with soap and water before eating, drinking, smoking, or applying cosmetics and at finish of job.

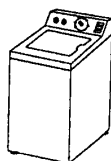

Laundry clothes separately.

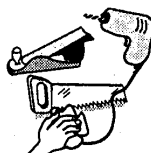

EQUIPMENT

Clean tools and equipment away from the work area.

QUALITY ASSURANCE

Did you do your part to inform and protect everyone from lead poisoning?

Work properly completed as requested	Yes	No	N/A*
Work areas cleaned properly	Yes	No	N/A
Contaminated debris properly bagged, sealed and labeled	Yes	No	N/A
Resident's belongings returned to original place	Yes	No	N/A
Resident notified of job completion	Yes	No	N/A
Other lead "problems" noted	Yes	No	N/A
If "Yes", other lead problems reported	Yes	No	N/A

Signature _____

Date/Time _____

Unit/Address _____

*N/A means not applicable

APPENDIX "P"

WORKMANSHIP AND APPLICATION CONDITIONS:

1. All materials and labor will have a minimum one (1) year warranty.
2. Paint only in dry weather when temperature is 50 degrees Fahrenheit or higher. Stop exterior work early to permit paint film to set up before condensation caused by night temperature drops occur. Do not begin painting until all surfaces are moisture free.
3. Sweep dust, dirt and debris away before painting.
4. Follow all directions on labels when applying paint. Contractor's work must conform to the manufacturer's paint instructions on the labels and product data sheets.
5. Paint only dry surfaces (less than 15% moisture). Cementitious substrates' moisture content must not exceed 25% prior to coating application.
6. All work shall be accomplished by skilled workmen familiar with and trained to do this type of work, they shall be qualified to operate or use equipment and rigging needed to accomplish the work.
7. All equipment shall be in sound working condition and must meet all OSHA Safety Standards. All workers must be trained in the operation of all equipment used on this project.
8. Materials shall be applied evenly free of runs, sags, pinholes or lap marks.
9. Only manufacturer's thinners may be used to thin the respective products and in the amounts prescribed.
10. All shrubbery, outside carpeting, water tanks, sprinkler systems and other equipment not listed shall be fully protected against damage during each stage of the painting project.
11. All exterior substrates designed not to receive paint shall be kept free of paint residue.
12. Normal safety signs, necessary lighting and temporary fencing around work areas shall be installed and maintained in accordance with OSHA requirements while work is in progress.
13. The Contractor will perform all work using accomplished and skilled craftsmen familiar with and trained to perform the scope of work specified. They will also be qualified to operate and/or use all equipment.
14. The Contractor shall see that all surface preparation and material application is performed in accordance with label directions, product technical data sheets, the written specification contained herein, and standard industry practices. Failure of the paint and/or coating system due to improper surface preparation, application: or material usage or handling is solely the responsibility of the Contractor.

15. The Contractor will see that all substrates are completely dry and moisture free prior to the application of any and all material. The Contractor will take into consideration the humid climate of Florida during the application process of all work.
16. The Contractor will apply material in accordance with the Manufacturer's approved product data sheet instructions to achieve specified dry film thickness (DFT). The Contractor will apply material at a rate not exceeding that recommended by the Manufacturer for the surface being coated.
17. The Contractor will apply finish coats in a manner that yields a smooth finish, free of brush marks, streaks, laps or pile-ups of material, skips or holidays.
18. The Contractor will be responsible to see, by reasonable and visible conformation, that all surfaces to be finished are free of defects from substrate and/or previous applicators. Defects that may affect his application finish appearance, which cannot be corrected shall be documented to Owner and/or Project Coordinator prior to application of finish material.
19. Abutment of edges of different material or color will be a sharp, clean cut off and will not overlap

GENERAL SURFACE PREPARATION:

1. The Contractor is responsible to see that all surfaces and substrates to be primed, sealed, painted, stained, or waterproofed are clean and free of foreign material, dust, dirt, grease, oil, or any substance which may adversely affect the performance of the coating before the application process begins
2. The Contractor is responsible for the complete removal of all mildew spores and organic growth. Apply a solution of 2/3 cup trisodium phosphate, 1/3 cup detergent (such as "Tide"), and 1 quart of non-ammoniated chlorine (pool chlorine is preferred) with 3 quarts water to make a 1 gallon solution. It is recommended to apply a test sample to ensure the ratio of chlorine to water is strong enough to adequately kill the mildew, Apply the approved solution to all affected areas and allow to remain on the surface for 10 to 30 minutes. Using a course nylon bristle brush, scrub all affected areas, as needed. Rinse thoroughly to ensure all residue has been removed.
3. The Contractor is responsible to see that special attention is given to previously painted chalky surfaces. Thorough pressure cleaning must be performed whenever chalk is present. Regardless of how much chalk is removed, complete coverage of the substrate with a bonding sealer must be performed.
4. The Contractor is responsible to see that all surfaces to be coated will be pressure cleaned with a minimum of 2500 p.s.i. at a flow rate of no less than 4 gallons per minute. This process should perform the removal of all chalky, blistered, peeling, and cracking paint, dirt, dust, mildew, organic matter, cobwebs, grease, tar, and any foreign matter that may affect the adhesion and performance of the finish coat.
5. The Contractor is responsible to see that all masonry cracks and voids are repaired as per instructions listed under Section 9 Masonry Surfaces / Crack and Void Treatment Any deteriorated or failed caulk, sealant and/or patching compounds should be removed before

applying primers, block fillers or surface conditioners and prior to reapplying caulk, sealants and/or patching compounds.

6. The Contractor is responsible to remove all efflorescence. Apply a solution of 1 part muriatic acid to 5 parts water and apply to all affected areas. Using a coarse nylon bristle brush, scrub all affected areas. Allow to remain for 10 to 15 minutes. Rinse thoroughly to ensure that all residue has been removed.
7. The Contractor is responsible to see that all previously painted glossy surfaces are de-glossed with an approved de-glosser/degreaser and abraded before the paint application process begins. The edges of remaining old paint should be feathered to give the repainted surface a reasonably smooth appearance.
8. The Contractor is responsible to see that all surface rust and mill scale is removed in accordance with the Steel Structures Painting Council. This process should be performed to a minimum of SSPC-SP-2, Hand Tool Cleaning or SSPC-SP-3, Power Tool Cleaning.
9. The Contractor is responsible for notifying the Builder and/or Project Coordinator of all wood that is warped, cracked, water damaged or delaminating is repaired or replaced nails should be counter sunk nail holes and small cracks should be filled prior to painting.

MASONARY SURFACES:

1. Over a thoroughly cleaned surface, apply one coat of Color Wheel 950 Ti-Gard Conditioner, or approved equal, to all previously painted chalky surfaces receiving finish materials. When the sealer has dried, the surface should present a low or eggshell sheen. To determine proper reduction, it is recommended to do test applications prior to commencement of work.
2. Apply at a spread rate of no greater than 450 square feet per gallon.
3. Apply in an even, uniform manner, avoiding sags and runs Apply by brush, roller or spray application, maintaining a wet edge. Work material into the pores of surface. Brush material into cracks to be detailed.
4. Allow a minimum of 24 hours curing time before recoating.
5. Remove any deteriorated caulking or sealant around aluminum, metal or wood windows, doors, exterior decorative bands or anywhere caulking or sealant has been applied. Determine that surface is clean and free of foreign material, mildew, moisture, dirt, sanding dust, ceiling texture or any substance which may adversely affect the performance of the sealant before the application process begins. Thoroughly apply sealant to all joints, seams, miters, voids, tops, sides and bottoms of interior trim, tops, sides and bottoms of exterior bands, corners and junctures where any dissimilar materials, masonry and non-masonry surfaces (i.e. masonry to wood trim) meet and drywall and non-drywall surfaces (ie interior drywall to interior wood trim).
6. Apply a continuous bead of Color Wheel Optima 50 Year Acrylic Urethane Sealant (RCS-4), or approved equal, to all areas described above and to all dissimilar materials - masonry to wood trim, metal to wood, etc., and any exposed area where water could enter behind paint film or substrate and cause damage. Tool or stipple to match surrounding substrate

texture. For best results, cured beads should be between 1/8"-1/2" wide and 1/8" -1/4" deep.

7. Allow a minimum of four to six hours (depending on climatic conditions) drying time before painting.
8. Shrinkage or Hairline Cracks (1/32" or less):

Apply Kover Krack Brush Grade Elastomeric Patching Compound, or approved equal, (Smooth or Textured) generously working firmly into crack or void (thickness should be 1/32" at center) see diagram 1

Using a broad knife or a brush, feather" or stipple the material on each side, thickness of 1/32" at center should be smoothed to 0" over a 2-inch area. This gradual reduction in thickness helps conceal the patch and allows the elongation characteristics of the patching compound to work effectively, this technique will also help to match the surrounding substrate texture so as not to appear as an obvious patch.

9. **Non-Structural Movement Cracks (1/32" to 1/16"):**

- 9.1 To cracks and voids equal to 1/32" apply Kover Krack Brush Grade Elastomeric Patching Compound, or approved equal, (Smooth or Textured) generously working firmly into crack or void (thickness should be 1/16" at center) same as diagram 1 and instruction above.
- 9.2 Cracks and voids 1/32" to 1/16" should be routed larger than 1/16" wide and 1/16" deep to form a v-shape, see diagram 2. Flush with water, allow to dry thoroughly. Prime area with Color Wheel 1252 Quick Cure Acrylic Conditioner or approved equal. Insert appropriate size closed cell foam backer rod, if needed. Apply Lighthouse Products RCS-4 Acrylic Urethane High Performance Sealant or approved equal. Gun material firmly into crack or void (firmly secure backer rod, if used), leaving no pockets.
- 9.3 Allow polyurethane sealant to thoroughly cure and coat with Kover Krack Knife Grade Elastomeric Patching Compound, or approved equal, (Smooth or Textured) thickness should be 1/32" at center.
- 9.4 Using a broad knife or a brush, "feather" or stipple the material on each side, thickness of 1/32" at center should be smoothed to 0" over a 2-inch area. This gradual reduction in thickness helps conceal the patch and allows the elongation characteristics of the patching compound to work effectively. This technique will also help to match the surrounding substrate texture so as not to appear as an obvious patch.

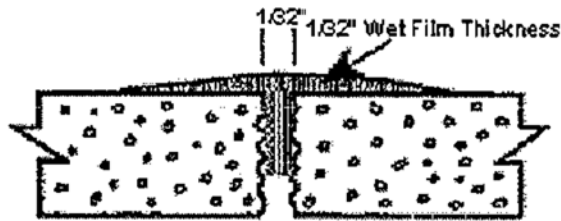

Diagram 1

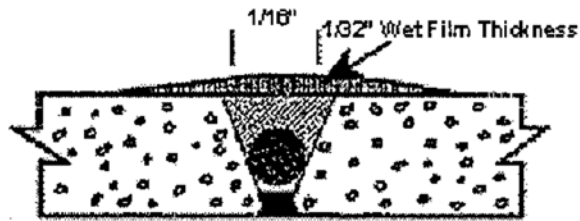

Diagram 2

10. Apply one coat of Color Wheel Flex Lox 1240 Line Exterior Coating, or approved equal.
11. Apply at a spread rate of no greater than 200 square feet per gallon to achieve a minimum dry film build of no less than 3,6 mils and until a solid and uniform finish is achieved.
12. Apply by brush, roller or spray application. Maintain a wet edge Apply at such a rate as to avoid runs and sags.
13. If airless spray is used on porous surfaces, back roll/brush all surfaces with a wet roller/brush. Work material into pores until a solid (pinhole free) finish is achieved.
14. Allow a minimum of 4 hours curing time if recoating is to be performed.

Note:

Specification may list paint systems as one and/or two finish coat, due to certain tinted colors, low hiding colors or radical color changes, industry standards may require the addition of more finish coats.

DRYWALL CEILINGS (BREEZEWAYS, BALCONY, PATIO, etc.)

Note:

Determine that surface is clean and free of foreign material, mildew, moisture, dirt, or any substance which may adversely affect the performance of the coating before the application process begins.

If chalk or oxidation is present on the surface affect cleaning a chalk binding primer must be used prior to application of spot primer and finish.

Primer:

1. Spot prime any new areas, bare areas and imperfections with one coat of Color Wheel Optima 330 All Prime or approved equal.
2. Apply at a spread rate of no greater than 350 square feet per gallon to achieve a dry film build of no less than 1 6 mils and until a solid and uniform finish is achieved.
3. Work material into pores until a solid (pinhole free) finish is achieved. Maintain a wet edge. Apply at such a rate as to avoid runs and sags.

4. Allow a minimum of 4 hours drying time, then lightly sand before recoating.

Finish:

1. Apply one coat of Color Wheel Flex Lox 1240 Line Exterior Coating or approved equal.
2. Apply at a spread rate of no greater than 350 square feet per gallon to achieve a minimum dry film build of no less than 2.0 mils and until a solid and uniform finish is achieved.
3. Apply by brush, roller or spray application Maintain a wet edge. Apply at such a rate as to avoid runs and sags.
4. If airless spray is used on porous surfaces back roll/brush all surfaces with a wet roller/brush. Work material into pores until a solid (pinhole free) finish is achieved.
5. Allow a minimum of 4 hours curing time if recoating is to be performed.

Note:

Specification may list paint systems as one and/or two finish coat, due to certain tinted colors, low hiding colors or radical color changes, industry standards may require the addition of more finish coats.